



## Series 6102

**Zetco WaterMarked  
DZR Brass Ball Valve  
Press-fit x MI  
Lever Handle**

### DESCRIPTION

A DZR brass ball valve WaterMark approved to AS 5830.1 (Licence WM-000110) for use with potable water. The body has a male connection to connect the valve to female fittings and a press-fit connection which can be crimped using a range of popular V profile tools to form a secure, flame-free o-ring seal against copper pipework.

### FEATURES

<b>Design</b>	<ul style="list-style-type: none"> <li>Forged dezincification resistant brass body</li> <li>Blow-out proof stem to prevent leakage</li> <li>Conical PTFE stem sealing system for additional leak protection</li> </ul>
<b>Production</b>	<ul style="list-style-type: none"> <li>Manufactured in Italy under ISO 9001 Quality Management System</li> <li>All valves are pressure tested during production</li> <li>Additional testing to DVGW VP 614</li> </ul>
<b>Technical</b>	<ul style="list-style-type: none"> <li>Press-fit connection conforming to AS 3688</li> <li>Male ISO 7/1 R (BSP) threaded connection</li> <li>Flow control: on/off only, not intended for throttling</li> <li>Flow capacity: Full bore</li> <li>Temperature range: -15°C to 110°C</li> <li>Max. pressure: 2500 kPa (refer to graph)</li> <li>Use with Viega®, Rothenberger® &amp; KemPress® V-profile tools only</li> <li>Must be installed according to accompanying instructions (see p. 3-4)</li> </ul>
<b>Options &amp; Variants</b>	<ul style="list-style-type: none"> <li>Size range: DN15 (1/2") to DN50 (2")</li> <li>Series 6100 WaterMarked press-fit x press-fit lever handle</li> <li>Series 6101 WaterMarked press-fit x female lever handle</li> <li>Series 6109 WaterMarked press-fit x male lockable lever handle</li> <li>Series 6202 AGA approved press-fit x male lever handle</li> </ul>

**BIM-MEP<sup>AUS</sup>**



**WaterMark**

IAPMO WM-000110  
AS 5830.1

# Series 6102

Zetco WaterMarked DZR Brass Ball Valve  
Press-fit x MI Lever Handle



## DIMENSIONAL AND COMPONENT DIAGRAM

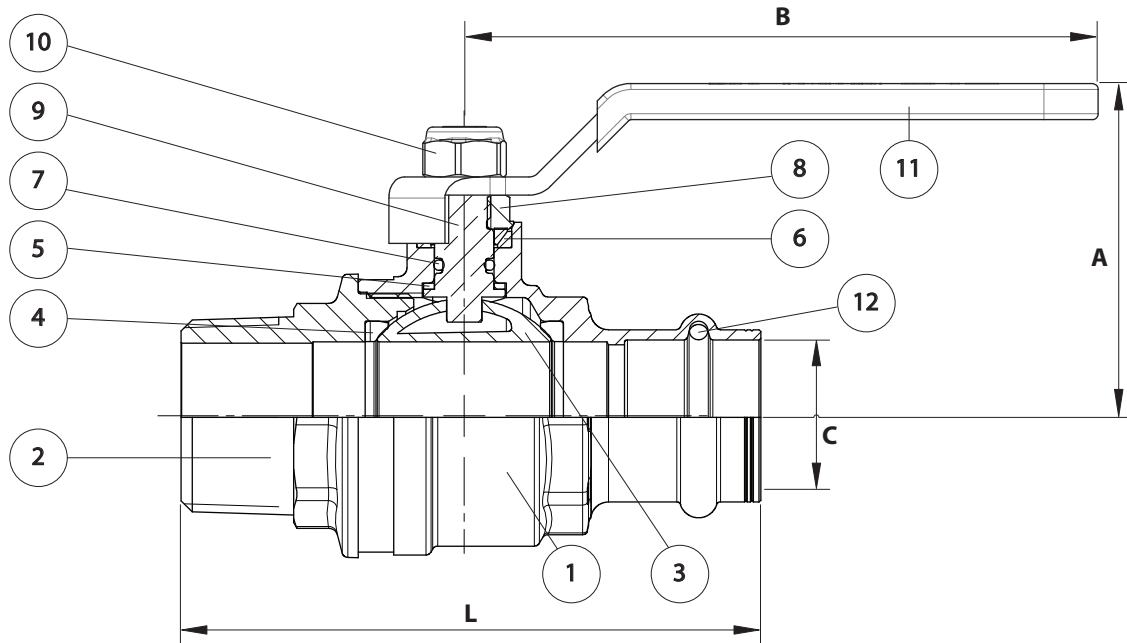

PARTS MATERIALS		
POS.	PART	MATERIAL
1	BODY	DZR BRASS
2	END ADAPTOR	DZR BRASS
3	BALL	DZR BRASS (CHROME PLATED)
4	SEAL	PTFE
5	THRUST WASHER	PTFE
6	CONICAL SEAL	PTFE
7	O-RING	HNBR
8	GLAND NUT	BRASS
9	STEM	DZR BRASS
10	NUT	ZINC PLATED STEEL
11	HANDLE	ZINC PLATED STEEL
12	O-RING	EPDM PEROXIDE

DIMENSIONS (mm)							
Prod. Code	DN	C	A	B	L	Kv	Wgt Kg
6102015	15	12.8	44	85	71	15	0.207
6102020	20	19.2	52	105	88	28	0.364
6102025	25	25.8	56	105	98	39	0.535
6102032	32	32.1	68	130	111	84	0.870
6102040	40	38.5	74	130	134	156	1.30
6102050	50	51.2	88	165	157	243	2.06

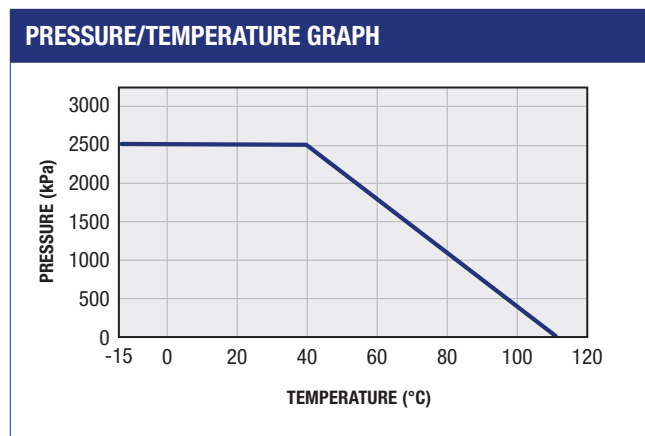



### Press-fit Information

For use with Viega®, Rothenberger®, KemPress® V-profile tools only

#### IMPORTANT INSTALLATION INSTRUCTIONS

Follow each step carefully



#### STEP 1

Refer to the design guidelines overleaf for important dimensions which must be considered prior to installation.

Use only Type A & B copper pipe complying with AS 1432.

Cut the copper pipe to the required length.

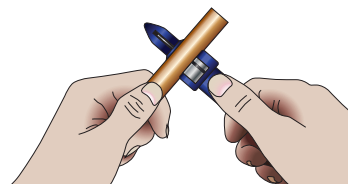

#### STEP 2

Carefully deburr the end of the pipe;

- INSIDE to minimise turbulence and pressure loss, and
- OUTSIDE to avoid damage to the o-ring during insertion.

For existing installations, ensure that the copper pipe complies with AS 1432 and is free of defects and in good condition.

Clean the end of the pipe with emery paper or a soft scourer.

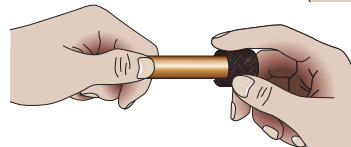
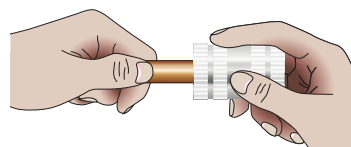

#### STEP 3

Measure and mark the correct insertion depth on the copper pipe.

Size (mm)	15	20	25	32	40	50
Depth (mm)	17	22	23	25	31	39

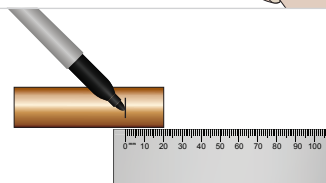

#### STEP 4

Ensure that you are using the correct valve or fitting for your application (water or gas) and the o-rings are correctly positioned.

Check that the ends are completely free of swarf, sharp metal or other debris which may cause damage the o-rings.

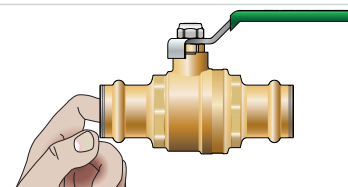

#### STEP 5

Push the valve or fitting onto the copper pipe up to the insertion depth. Recheck engagement with the pipe prior to pressing.

Rest the raised bump in the groove of the press tool and operate press tool according to manufacturer's instructions. Inspect joint.

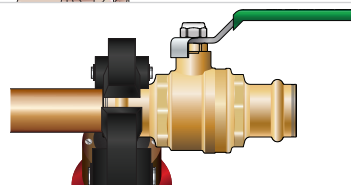

#### NOT SUITABLE FOR

Solar hot water systems, medical gases, refrigeration and air-conditioning gases, acetylene, urea solution, glycerin triacetate, coolant inhibitor, sodium hydroxide or ammoniac gases.

**WARNING DO NOT USE MINERAL OIL TO LUBRICATE THE O-RINGS**

#### WATER APPLICATIONS

Medium	Potable water
Max. Temp.	110°C
Max. Pressure	2500 kPa

#### GAS APPLICATIONS

Medium	NG, LPG
Max. Temp.	100°C
Max. Pressure	2100 kPa*

\*According to AS 5601 Table 4.1, operating pressure of consumer gas piping systems containing copper tube is limited to 200 kPa. Disclaimer: Zetco Valves Pty Ltd will not accept responsibility for damage caused by failure to follow the instructions & warnings provided.

INSTALLATION INSTRUCTION SHEET

© 06-2019

Also available for download at [www.zetco.com.au](http://www.zetco.com.au)



### Press-fit Information

For use with Viega®, Rothenberger®, KemPress® V-profile tools only  
**INSTALLATION DESIGN INFORMATION**  
 Follow carefully to avoid damage



DESIGN GUIDE

#### SPACE REQUIREMENTS

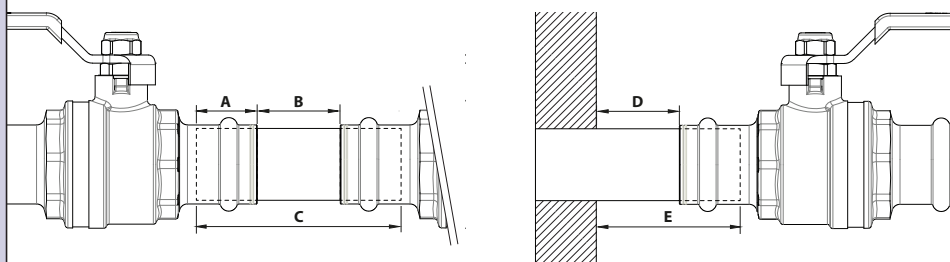

The table below shows the minimum distances required between a press joint and other objects.

Nom. Size mm	Pipe OD mm	A mm	B mm	C mm	D mm	E mm
DN15	12.70	17	10	50	60	80
DN20	19.05	22	10	60	60	85
DN25	25.40	23	10	62	60	86
DN32	31.75	25	20	76	60	88
DN40	38.10	31	20	88	60	94
DN50	50.80	39	20	110	60	106

#### BRAZING & SOLDERING

Brazing or soldering close to press joints may result in damage to the o-rings.  
 The table below shows the minimum distance required between a press joint and any brazing activity. In cases where this distance cannot be achieved, ensure that the valve or fitting is adequately protected from heat and kept cool during the brazing procedure.

Size (mm)	15	20	25	32	40	50
Min. Clearance	350	500	650	800	1000	1300



**WARNING**

Unpressed connections may not be detected during post-installation pressure testing due to a temporary sealing effect of the o-rings. To ensure that correct sealing has been achieved, visually inspect every joint to ensure that each one is pressed correctly.

The most recent version of this information sheet, plus additional technical information can be accessed at the Zetco website: [www.zetco.com.au](http://www.zetco.com.au)

Disclaimer: Zetco Valves Pty Ltd will not accept responsibility for damage caused by failure to follow the instructions & warnings provided.

© 06-2019

Also available for download at [www.zetco.com.au](http://www.zetco.com.au)