



Series 6150

Zetco WaterMarked Underground DZR Brass Ball Valve Press-fit x Press-fit

DESCRIPTION

A DZR brass ball valve WaterMark approved to AS 5830.1 (Licence WM-000110) for use in underground potable water installations. The sturdy DZR brass adaptor enables the valve to be operated with a key from above ground while the body features integral press-fit end connections which can be crimped using a range of popular V profile tools.

FEATURES

Design	<p>Forged dezincification resistant brass body</p> <p>Blow-out proof stem to prevent leakage</p> <p>Conical PTFE stem sealing system for additional leak protection</p> <p>Fitted with adaptor for underground installation</p>
Production	<p>Manufactured in Italy under ISO 9001 Quality Management System</p> <p>All valves are pressure tested during production</p> <p>Additional testing to DVGW VP 614</p>
Technical	<p>Press-fit connection conforming to AS 3688</p> <p>Flow control: on/off only, not intended for throttling</p> <p>Flow capacity: Full bore</p> <p>Temperature range: -15°C to 110°C</p> <p>Max. pressure: 2500 kPa (refer to graph)</p> <p>Use with Viega®, Rothenberger® & KemPress® V-profile tools only</p> <p>Must be installed according to accompanying instructions (see p. 3-4)</p>
Options & Variants	<p>Size range: DN15 (1/2") to DN50 (2")</p> <p>Series 6100 WaterMarked press-fit x press-fit lever handle</p> <p>Series 6107 WaterMarked press-fit x press-fit lockable lever handle</p> <p>Series 6110 WaterMarked press-fit x press-fit extended spindle</p> <p>Series 2505 WaterMarked DZR brass BSP female underground</p>



WaterMark
IAPMO WM-000110
AS 5830.1

Series 6150

Zetco WaterMarked Underground

DZR Brass Ball Valve Press-fit x Press-fit



DIMENSIONAL AND COMPONENT DIAGRAM

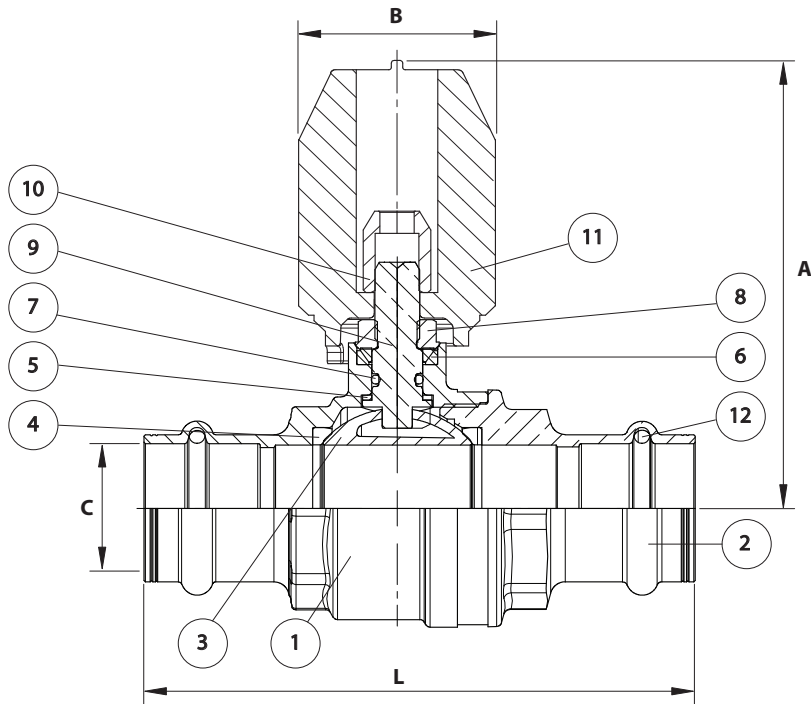

PARTS MATERIALS		
POS.	PART	MATERIAL
1	BODY	DZR BRASS
2	END ADAPTOR	DZR BRASS
3	BALL	DZR BRASS (CHROME PLATED)
4	SEAL	PTFE
5	THRUST WASHER	PTFE
6	CONICAL SEAL	PTFE
7	O-RING	HNBR
8	GLAND NUT	BRASS
9	STEM	DZR BRASS
10	CAP	DZR BRASS (SIZES DN15-DN40)
		STAINLESS STEEL (DN50)
11	ADAPTOR	DZR BRASS
12	O-RING	EPDM PEROXIDE

DIMENSIONS (mm)							
Prod. Code	DN	C	A	B	L	Kv	Wgt Kg
6150015	15	12.8	82	27	78	15	0.410
6150020	20	19.2	82	27	99	28	0.483
6150025	25	25.8	84	27	107	39	0.572
6150032	32	32.1	96	27	119	84	1.20
6150040	40	38.5	102	27	151	156	1.91
6150050	50	51.2	116	27	174	243	2.99

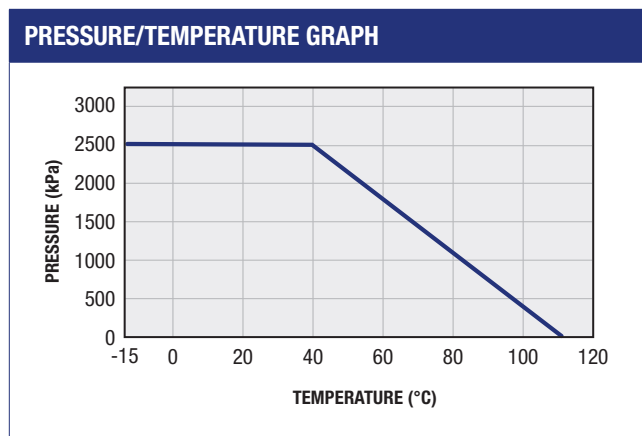



Press-fit Information

For use with Viega®, Rothenberger®, KemPress® V-profile tools only

IMPORTANT INSTALLATION INSTRUCTIONS

Follow each step carefully



STEP 1

Refer to the design guidelines overleaf for important dimensions which must be considered prior to installation.

Use only Type A & B copper pipe complying with AS 1432.

Cut the copper pipe to the required length.

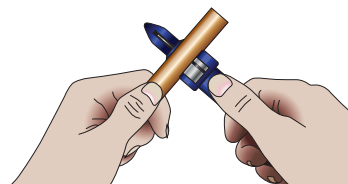

STEP 2

Carefully deburr the end of the pipe;

- INSIDE to minimise turbulence and pressure loss, and
- OUTSIDE to avoid damage to the o-ring during insertion.

For existing installations, ensure that the copper pipe complies with AS 1432 and is free of defects and in good condition.

Clean the end of the pipe with emery paper or a soft scourer.

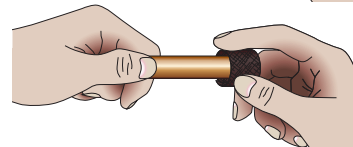
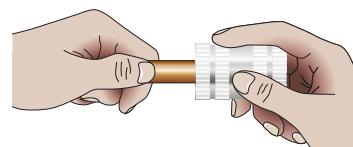

STEP 3

Measure and mark the correct insertion depth on the copper pipe.

Size (mm)	15	20	25	32	40	50
Depth (mm)	17	22	23	25	31	39

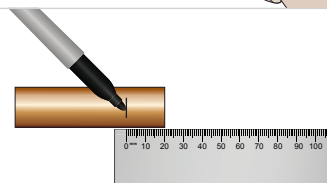

STEP 4

Ensure that you are using the correct valve or fitting for your application (water or gas) and the o-rings are correctly positioned.

Check that the ends are completely free of swarf, sharp metal or other debris which may cause damage the o-rings.

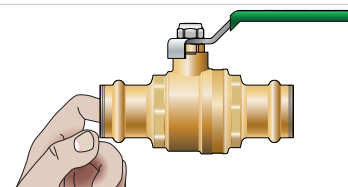

STEP 5

Push the valve or fitting onto the copper pipe up to the insertion depth. Recheck engagement with the pipe prior to pressing.

Rest the raised bump in the groove of the press tool and operate press tool according to manufacturer's instructions. Inspect joint.

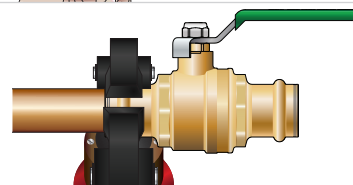

NOT SUITABLE FOR

Solar hot water systems, medical gases, refrigeration and air-conditioning gases, acetylene, urea solution, glycerin triacetate, coolant inhibitor, sodium hydroxide or ammoniac gases.

WARNING DO NOT USE MINERAL OIL TO LUBRICATE THE O-RINGS

WATER APPLICATIONS

Medium	Potable water
Max. Temp.	110°C
Max. Pressure	2500 kPa

GAS APPLICATIONS

Medium	NG, LPG
Max. Temp.	100°C
Max. Pressure	2100 kPa*

*According to AS 5601 Table 4.1, operating pressure of consumer gas piping systems containing copper tube is limited to 200 kPa. Disclaimer: Zetco Valves Pty Ltd will not accept responsibility for damage caused by failure to follow the instructions & warnings provided.

INSTALLATION INSTRUCTION SHEET

© 06-2019

Also available for download at www.zetco.com.au



Press-fit Information

For use with Viega®, Rothenberger®, KemPress® V-profile tools only
INSTALLATION DESIGN INFORMATION
 Follow carefully to avoid damage



DESIGN GUIDE

SPACE REQUIREMENTS

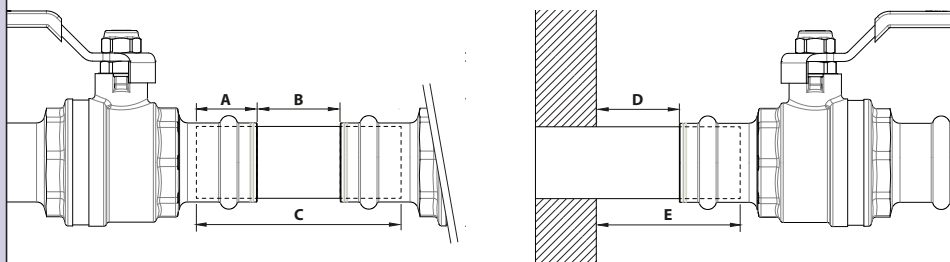

The table below shows the minimum distances required between a press joint and other objects.

Nom. Size mm	Pipe OD mm	A mm	B mm	C mm	D mm	E mm
DN15	12.70	17	10	50	60	80
DN20	19.05	22	10	60	60	85
DN25	25.40	23	10	62	60	86
DN32	31.75	25	20	76	60	88
DN40	38.10	31	20	88	60	94
DN50	50.80	39	20	110	60	106

BRAZING & SOLDERING

Brazing or soldering close to press joints may result in damage to the o-rings. The table below shows the minimum distance required between a press joint and any brazing activity. In cases where this distance cannot be achieved, ensure that the valve or fitting is adequately protected from heat and kept cool during the brazing procedure.

Size (mm)	15	20	25	32	40	50
Min. Clearance	350	500	650	800	1000	1300



WARNING

Unpressed connections may not be detected during post-installation pressure testing due to a temporary sealing effect of the o-rings. To ensure that correct sealing has been achieved, visually inspect every joint to ensure that each one is pressed correctly.

The most recent version of this information sheet, plus additional technical information can be accessed at the Zetco website: www.zetco.com.au

Disclaimer: Zetco Valves Pty Ltd will not accept responsibility for damage caused by failure to follow the instructions & warnings provided.

© 06-2019

Also available for download at www.zetco.com.au